

Part No.	WR-PA4008UW/C		
Emitted Color	High Super White	Len's Color	Water Clear
Chip Material	InGaN		

### Features:

Compatible with automatic placement equipment

Compatible with reflow solder process

This product doesn't contain restriction Substance, comply ROHS standard.

### Applications:

Backlight for LCD or backlighting in dashboard and switch

General use for indicators

### Package Dimensions:

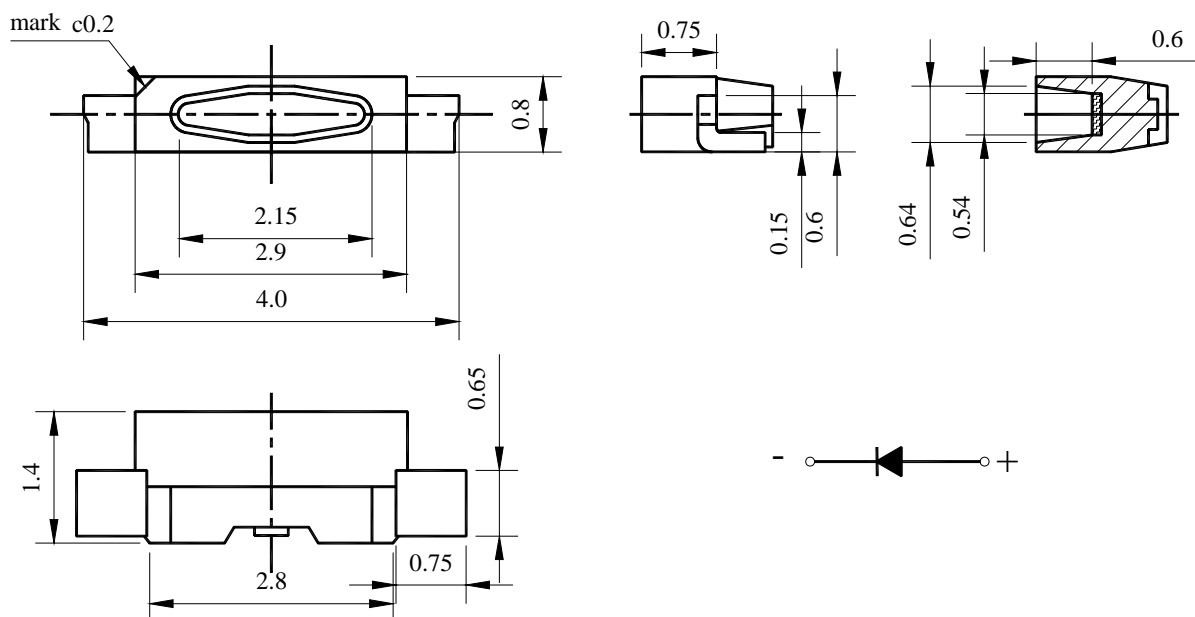

Unit : mm

Toleranc :  $\pm 0.2$ mm unless otherwise noted

Electrodes: Ag Plating Copper Alloy

Encapsulating Resin: Epoxy Resin

Package: Heat-Resistant Polymer

[www.meisemi.com](http://www.meisemi.com)



Absolute Maximum Rating ( Ta=25 )

Parameter	Symbol	Max.	Unit
Power Dissipation	P <sub>M</sub>	70	Mw
Pulse Forward Current (1/10 duty and 1mec width)	I <sub>FP</sub>	60	mA
DC Forward Current	I <sub>F</sub>	20	mA
Reverse Voltage	V <sub>R</sub>	5	V
Operating Temperature Range	Topr	-30 ~ 85	
Storage Temperature Range	Tstg	-40 ~ 100	

Electrical Optical Characteristics ( Ta=25 )

Parameter	Symbol	Typ.	Max.	Unit	Test Condition
Luminous Intensity	I <sub>v</sub>	400	--	mcd	I <sub>F</sub> =20mA
Forward Voltage	V <sub>F</sub>	3.3	3.8	V	I <sub>F</sub> =20mA
Reverse Current	I <sub>R</sub>	--	10	uA	V <sub>R</sub> =5V
Chromaticity Coordinates	x	0.28	--		I <sub>F</sub> =20mA
	y	0.29			
Horizontal Viewing Angle	2 1/2	130	--	Deg.	I <sub>F</sub> =20mA

Parameter Classification

Forward Voltage ( I <sub>F</sub> =20mA )		Chromaticity Coordinates ( I <sub>F</sub> =20mA )		Luminous Intensity ( I <sub>F</sub> =20mA )	
Code	Min~Max	Code	Min~Max	Code	Min~Max
V	3.2~3.3	BS~CF	X:0.27~0.30	U	320~400
W	3.3~3.4		Y:0.27~0.30	V	400~500

Classing Marking:

For example :

003VKBSS

Code Order : Chip code—Voltage—Wavelength—Chromaticity Coordinates—Luminous Intensity  
www.meisemi.com

Package Label:

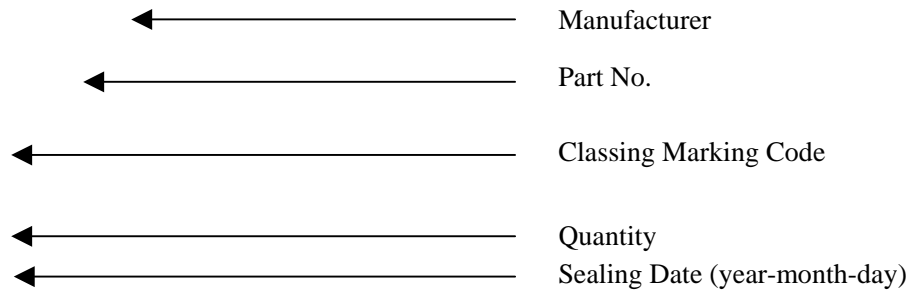

Soldering Pad Dimensions:

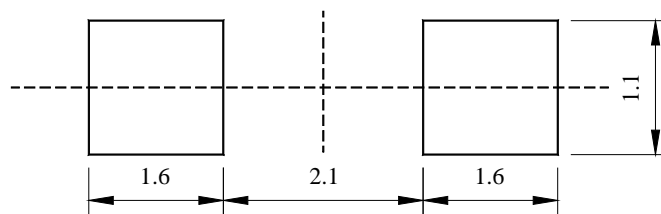

Soldering Conditions (Maximum allowable soldering conditions)

1、Reflow soldering profile

<Lead-free solder>

<Lead solder>

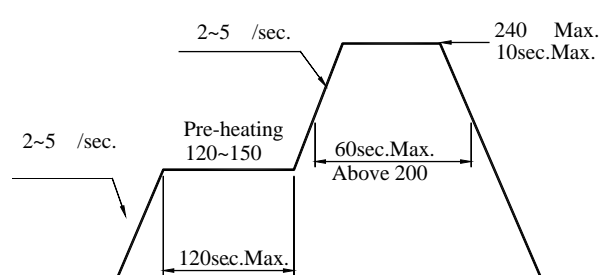
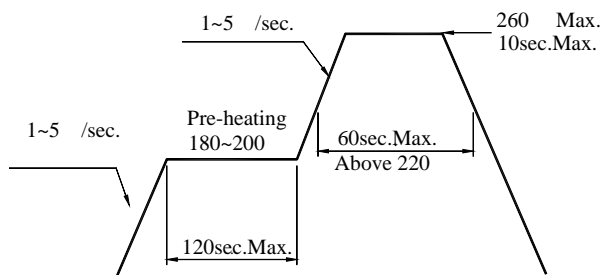

2、Soldering Iron

Power dissipation of Iron should be smaller than 25W, and temperature should be controllable. The work must be finished within 3sec under 300 , only once.

- Do not stress its resin while soldering.
- After soldering, do not warp the circuit board.
- Pay attention to electrostatic (ESD)

[www.meisemi.com](http://www.meisemi.com)

Typical Electro-Optical Characteristics Curves :

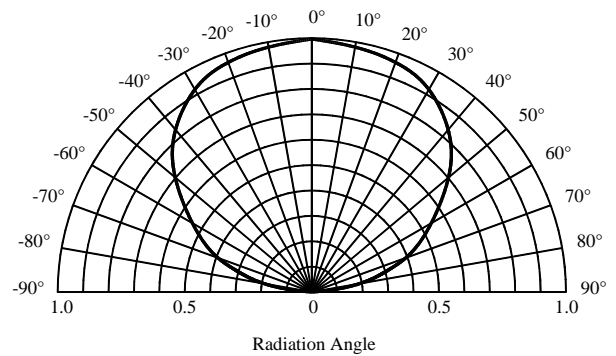
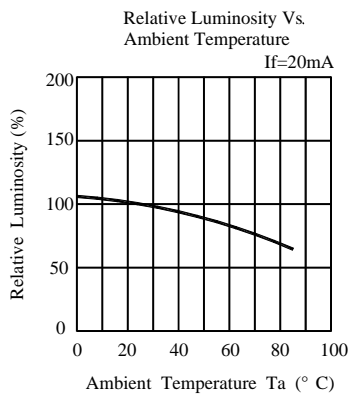
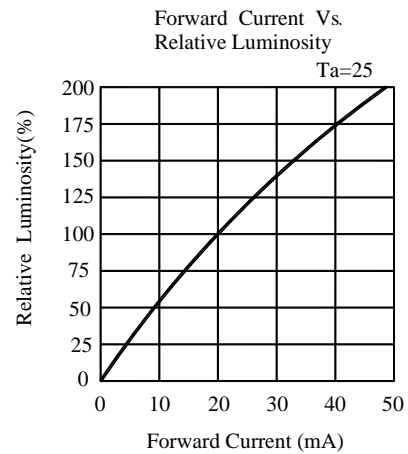
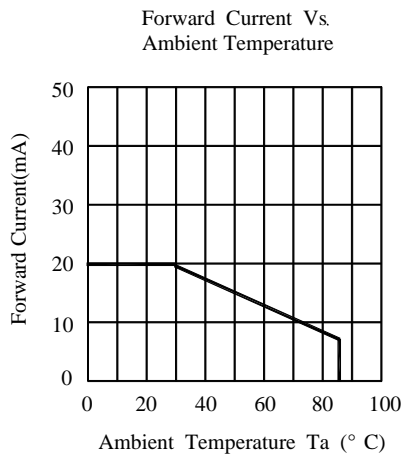
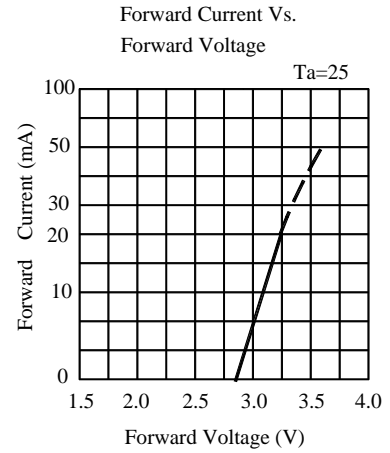
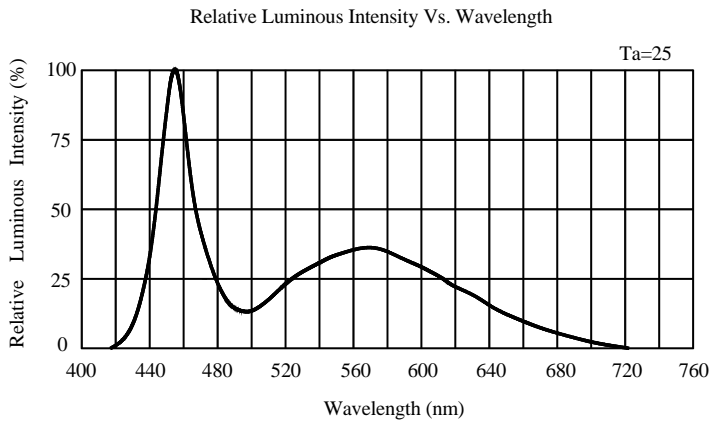



## Reliability Test Items and Conditions

NO	Test Item	Test Conditions	Duration	Sample	Ac/Re
1	Temperature Cycle	-40 ~ 25 ~ 100 ~ 25 30min 5min 30min 5min	50cycles	100	0/1
2	High Temp. Storage	Ta=100	1000hours	100	0/1
3	Temp.& Humidity Test	Ta=85 RH=85%	1000hours	100	0/1
4	Low Temp. Storage	Ta=-40	1000hours	100	0/1
5	Operating Life Test	Ta=25 ± 5 DC IF=15mA	1000hours	100	0/1
6	Solder Heat	Tsol=260 ± 5 , 10s	1times	20	0/1

### Cautions

#### 1、 Package

When moisture is absorbed into the package it may vaporize and expand during soldering. There is a possibility that this can cause exfoliation of the contacts and damage to the optical characteristics of the LEDs. So the moisture proof package is used to keep moisture to a minimum in the package.

#### 2、 Storage

Before opening the package: The LEDs should be kept at 5~30°C and 60%RH or less. The LEDs should be used within a year.

After opening the package: The LED must be used within 24 hours, else should be kept at 5~30 and 30% RH or less. The LEDs should be used within 7days after opening the package. If unused LEDs remain, they should be stored in moisture proof packages, recommended to return the LEDs to the original moisture proof bag and to reseal the moisture proof bag again.

If the LEDs have exceeded the storage time, baking treatment should be performed more than 12 hours at 60 ± 5°C.

3、 The LED electrode sections are comprised of a gold plated. The gold surface may be affected by environments which contain corrosive gases and so on. Please avoid conditions which may cause the LED to corrode or discolor. This corrosion or discoloration may cause difficulty during soldering operations. It is recommended that the User use the LEDs as soon as possible.

[www.meisemi.com](http://www.meisemi.com)



4、 Please avoid rapid transitions in ambient temperature, especially in high humidity environments where condensation can occur.

5、 Static Electricity

5.1、 These products are sensitive to static electricity charge, and users are required to handle with care. Particularly, if an current and or voltage which exceeds the Absolute Maximum Rating of Products is applied, the overflow in energy may cause damage to, or possibly result in electrical destruction of, the Products. The customer is requested to take adequate countermeasures against static electricity charge and surge when handling Products.

5.2、 Proper grounding of Products , use of conductive mat, conductive working uniform and shoes, and conductive containers are effective against static electricity and surge.

5.3、 Ground low-resistance areas where the product contacts, such as metal surfaces of the work platform, with a conductive mat (surface resistance  $10^6$ - $10^8$  ).

5.4、 A tip of soldering iron is requested to be grounded. An ionizer should also be installed where risk of static generation is high.

Notes:

1、 Above specification may be changed without notice. We will reserve authority on material change for above specification.

2、 When using this product, please observe the absolute maximum ratings and the instructions for the specification sheets. We assume no responsibility for any damage resulting from use of the product which does not comply with the instructions included in the specification sheets.